

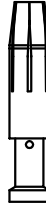





日期/Date	档案员 Filing Clerk	1			2			3			4			5						6					
		产品代号 Part code	产品料号 Part NO.	重量/Weight g	线径/Wire Gauge mm <sup>2</sup> AWG	d	D	剥线长度 Stripping length	标识 Identification	标识图 Identification No.	No.	No.1	No.2	No.3	No.4	No.5	No.6								
		CEGF-0.37	1010192200301	1.37	0.14-0.37	26-22	0.90	1.8	7.5	no groove	No.1	标示图 Marked Graph													
		CEGF-0.50	1010192200401	1.52	0.5	20	1.15	2.6	7.5	no groove	No.1														
		CEGF-0.75	1010192200601	1.54	0.75	18	1.30	2.6	7.5	1 groove	No.2														
		CEGF-1.0	1010192200801	1.54	1.0	18	1.45	2.6	7.5	1 groove	No.3														
		CEGF-1.5	1010192200901	1.58	1.5	16	1.75	3.0	7.5	2 groove	No.4														
		CEGF-2.5	1010192201001	1.62	2.5	14	2.25	3.5	7.5	3 groove	No.5														
		CEGF-3.0	1010192201101	1.54	3.0	12	2.55	3.7	7.5	wide groove	No.6														
		CEGF-4.0	1010192201201	1.55	4.0	12	2.85	3.9	7.5	no groove	No.1														



技术参数:  
 - 材料: 铜合金  
 - 表面处理: 镀金  
 - 额定电流: 16A  
 - 接触电阻: ≤1mΩ  
 - 线径范围: 1.0mm<sup>2</sup>(18 AWG)  
 - 可插拔次数: ≥500

Technical specification:  
 - Material: copper alloy  
 - Surface: hard-gold plated  
 - Rated current: 16A  
 - Contact resistance: ≤1mΩ  
 - Wire gauge: 1.0mm<sup>2</sup>(18 AWG)  
 - Mating cycles: ≥500

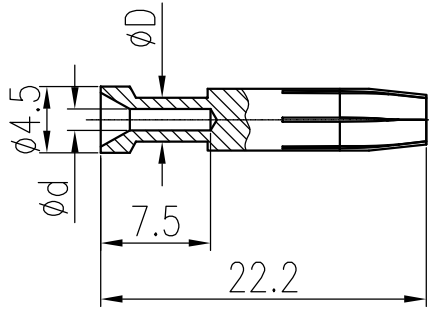
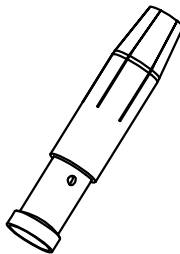

表面处理 Finish		-		图号 Drawing No.		-	
材料 Material		-		产品代号 Part Code		CEGF-1.0	
比例 Scale		2:1		产品料号 Part No.		1010192200801	
版本 REV.		V1.5		产品名称 Part Name		-	
重量 Weight		1.54g		数量 Qty.		-	
日期/Date		19.02.2019		批准 Approved		HQ ZHANG	
姓名/Name		HZ LAN		日期/Date		19.02.2019	
变更描述/Description		标准化 Stand.		姓名/Name		HZ LAN	
处数 Number		-		日期/Date		19.02.2019	
标记 Mark		-		姓名/Name		HZ LAN	
绘图 Drawn		YL YE		日期/Date		19.02.2019	
审核 Checked		HZ LAN		姓名/Name		HZ LAN	
工艺 Process		-		日期/Date		19.02.2019	

 厦门唯恩电气有限公司  
 XIAMEN WAIN ELECTRICAL CO.LTD

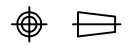

All Dimensions in mm  
 Original Size DIN A 4