







日期/Date	档案员 Filing Clerk	1			2			3			4			5						6					
		产品代号 Part code	产品料号 Part NO.	重量/Weight g	线径/Wire Gauge mm <sup>2</sup> AWG	d	D	剥线长度 Stripping length	标识 Identification	标识图 Identification No.	No.	No.1	No.2	No.3	No.4	No.5	No.6								
		CEGF-0.37	1010192200301	1.37	0.14-0.37	26-22	0.90	1.8	7.5	no groove	No.1	标示图 Marked Graph													
		CEGF-0.50	1010192200401	1.52	0.5	20	1.15	2.6	7.5	no groove	No.1														
		CEGF-0.75	1010192200601	1.54	0.75	18	1.30	2.6	7.5	1 groove	No.2														
		CEGF-1.0	1010192200801	1.54	1.0	18	1.45	2.6	7.5	1 groove	No.3														
		CEGF-1.5	1010192200901	1.58	1.5	16	1.75	3.0	7.5	2 groove	No.4														
		CEGF-2.5	1010192201001	1.62	2.5	14	2.25	3.5	7.5	3 groove	No.5														
		CEGF-3.0	1010192201101	1.54	3.0	12	2.55	3.7	7.5	wide groove	No.6														
		CEGF-4.0	1010192201201	1.55	4.0	12	2.85	3.9	7.5	no groove	No.1														



技术参数:

- 材料: 铜合金
- 表面处理: 镀金
- 额定电流: 16A
- 接触电阻: ≤1mΩ
- 线径范围: 0.75mm<sup>2</sup>(18 AWG)
- 可插拔次数: ≥500

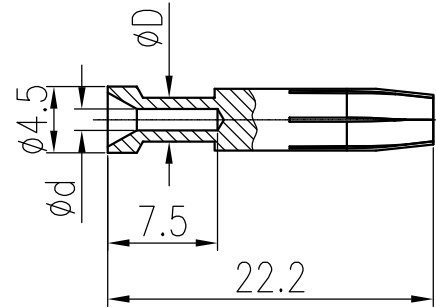
Technical specification:

- Material: copper alloy
- Surface: hard-gold plated
- Rated current: 16A
- Contact resistance: ≤1mΩ
- Wire gauge: 0.75mm<sup>2</sup>(18 AWG)
- Mating cycles: ≥500

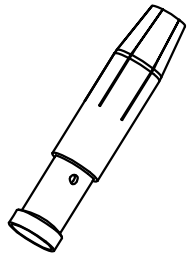

						表面处理 Finish		-		图号 Drawing No.		-	
						材料 Material		-		产品代号 Part Code		CEGF-0.75	
标记 Mark		处数 Number		变更描述/Description		签名 Signature		日期 Date		产品料号 Part No.		1010192200601	
姓名/Name		日期/Date		姓名/Name		日期/Date		比例 Scale		版本 REV.		重量 Weight	
Y L Y E		19.02.2019		-		-		2:1		V1.2		1.54g	
数量 Qty.		-		-		-		-		-		-	
产品名称 Part Name		-		-		-		-		-		-	
All Dimensions in mm Original Size DIN A 4		-		-		-		-		-		-	
批准 Approved		-		-		H Q Z H A N G		19.02.2019				<b>厦门唯恩电气有限公司</b> XIAMEN WAIN ELECTRICAL CO.LTD	