

日期/Date
 档案员
 Filing Clerk

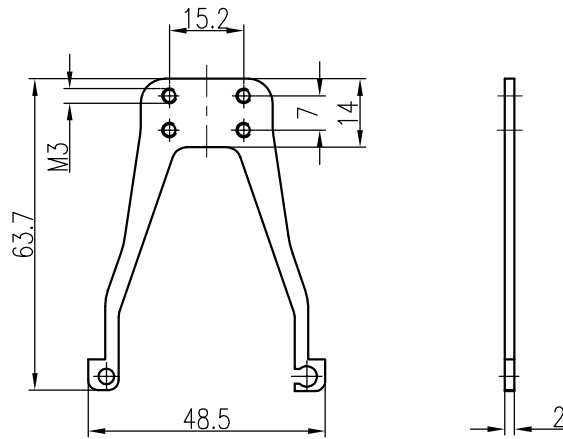

技术参数:
 - 规格: 6B
 - 材料: 铁
 装配在HM模块框架用于不封底下壳

Technical specification:
 - Size: 6B
 - Material: Iron
 For HM frames in housings bulkhead mounting

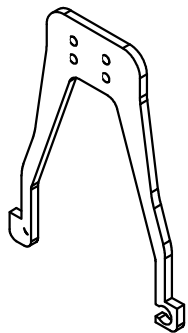

						表面处理 Finish	-			图号 Drawing No.	-
						材料 Material	-			产品代号 Part Code	M6B-PE
标记 Mark	处数 Number	变更描述/Description		签名 Signature	日期 Date					产品料号 Part No.	1980020030008
	姓名/Name	日期/Date		姓名/Name	日期/Date	比例 Scale	版本 REV.	重量 Weight	数量 Qty.	产品名称 Part Name	-
绘图 Drawn	HZ LAN	18.10.2016	标准化 Stand.	-	-	2:3	V1.0	12g	-		
审核 Checked	ZW WU	18.10.2016									
工艺 Process	-	-	批准 Approved	YY LUO	18.10.2016	All Dimensions in mm Original Size DIN A 4			厦门唯恩电气有限公司 XIAMEN WAIN ELECTRICAL CO.LTD		